



## Finite Element Method Analysis of Stress Intensity Factor in Different Edge Crack Positions, and Predicting their Correlation using Neural Network method

Zare Ali<sup>1\*</sup>, Kosari Esfahan S. Meysam<sup>2</sup>, Asadilman<sup>1</sup>, BighamAydin<sup>1</sup> and Bigham Yashar<sup>1</sup>

<sup>1</sup>Department of Mechanical Engineering, Universiti Tenaga Nasional, Kajang, MALAYSIA

<sup>2</sup>Department of Engineering, Islamic Azad University-Najafabad Branch, IRAN

Available online at: [www.isca.in](http://www.isca.in), [www.isca.me](http://www.isca.me)

Received 3<sup>rd</sup> July 2013, revised 11<sup>th</sup> August 2013, accepted 11<sup>th</sup> September 2013

### Abstract

According to the fracture mechanics, crack propagation in the body of structures may lead to a failure. In this field, Stress Intensity Factor is utilized to determine the stress intensity near the tip of a crack, and to predict if a crack starts to grow. The crack propagation can be determined by comparing Stress Intensity Factor to the Critical Stress Intensity Factor. This study attempts to analyze the Stress Intensity Factor in various edge cracks along the length of a finite plate which is under a uniform tension. Finite Element Method is utilized for the analysis. In addition, Neural Network Method is used to predict the correlation of Stress Intensity Factor and the position of edge crack along the length of a finite plate.

**Keyword:** Crack, stress intensity factor, finite element method, neural network.

### Introduction

Recent development in engineering structures shows that small cracks in the body of structures can be cause of failure despite the authenticity of elasticity theory and strength of materials. As a result, fracture mechanics field which is concerned with the propagation of cracks in materials has developed to study more about this subject. According to this, in fracture mechanics, there are three modes of fracture. In the first mode which is named as mode I or opening mode, tensile load is applied in perpendicular direction to the crack surface. In mode II which is known as sliding mode, shear force parallel to the crack surface is applied. Finally, mode III, sliding mode or tearing mode is when shear force is parallel to the crack front while the crack surface slides over each other in direction of Z axis. In all the modes, the original orientation of crack can be the main orientation of the crack propagation<sup>1</sup>.

In many situations, a mixed mode of crack extension which is called a superposition of modes could happen. In the case of superposition mode,  $\sigma_{ij}^I$ ,  $\sigma_{ij}^{II}$ ,  $\sigma_{ij}^{III}$  which are referred as stress in mode I, mode II and mode III respectively, can be integrated as components of  $\sigma_{ij}$  according to the formula (1)<sup>1</sup>:

$$\sigma_{ij} = \sigma_{ij}^I + \sigma_{ij}^{II} + \sigma_{ij}^{III} \quad (1)$$

By considering the previous three modes, and according to semi-inverse method of Irwin<sup>2,3</sup>, the relation between distance to the tip of crack, a; and stress component,  $\sigma$ , can be formulated as below in formula (2)<sup>1,4</sup>:

$$\sigma \approx \frac{k}{\sqrt{\pi a}} \quad (2)$$

Meanwhile, parameter k, Stress Intensity Factor (SIF), has an important role in the fracture mechanics since it characterizes the stress field in the crack tip region, and helps to predict the fracture condition and remaining life. SIF depends on the size and location of the crack, geometry, and the magnitude of load<sup>5</sup>. SIF is needed to be determined to predict the crack propagation<sup>6</sup>.

It is important to know the maximum allowable stress to determine when a crack starts to grow. One factor that can help engineer to determine this limitation is the critical stress intensity factor which is named as fracture toughness,  $K_c$ . According to this, crack stability can be determined by comparing K and  $K_c$ <sup>7</sup>.

In order to determine the stress intensity factor, various numerical methods were utilized. The methods were the boundary element method<sup>8,9</sup>, the meshless method<sup>10,11</sup>, the finite element method<sup>5,12-20</sup>, and virtual crack extension<sup>21,22</sup>.

The stress intensity factor for edge crack in finite plate can be achieved by the formula (3) when  $\left(\frac{h}{b}\right) \geq 1$  and  $\left(\frac{a}{b}\right) \leq 0.6$ , according to the figure-1<sup>4</sup>.

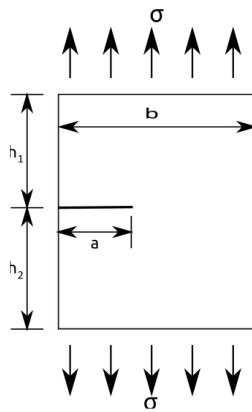

Figure-1

Edge crack in a finite plate under uniaxial stress

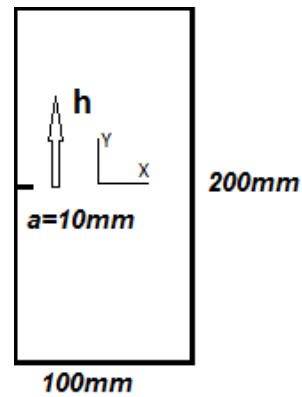

Figure-2

Steel plate with the thickness of 1 mm

$$K_I = \sigma\sqrt{\pi a} \left[ 1.12 - 0.23\left(\frac{a}{b}\right) + 10.6\left(\frac{a}{b}\right)^2 - 21.7\left(\frac{a}{b}\right)^3 + 30.4\left(\frac{a}{b}\right)^4 \right] \quad (3)$$

By this formula, SIF can be calculated when the edge crack is in the middle of the plate's length,  $h_1=h_2$ .

As the formula of stress intensity factor considers the edge crack position in the middle of the plate, this study attempts to determine the SIF in different edge crack position along the length of the rectangular finite plate, in Y axis, and find the correlation of SIF and edge crack position under uniform tension.

## Material and Methods

**Material and Geometry:** In this study, an edge crack in the steel plate with the Poisson ratio of 0.3 and elasticity modulus of 300Gpa, is studied. The 200 kPa of uniaxial stress is applied on the top and bottom edge of the plate. The plate size is 100mm\*200mm with the thickness of 1 mm. In this study, h is the distance from the middle of the plate length in Y axis. In addition, the length of the crack is 10mm.

**Finite Element Method:** Finite element analysis (FEM) has become commonplace in recent years, and is now the basis of a multibillion dollar per year industry<sup>23</sup>. The finite element methods (FEM) are techniques utilized for approximating differential equations to continuous algebraic equations by a finite number of variables<sup>24</sup>. This method is one of the most practical ways for analyzing structures with a large number of degrees of freedom<sup>25</sup>. To get a more accurate result from FEM, it is recommended to use some software in order to carry out the numerical computation part. In addition, saving time is another factor which motivates specialists to use software instead of solving problems manually<sup>26</sup>. Various FEM based software such as ABAQU are utilized to solve engineering problems. The general process of FEA is divided into three main phases, preprocessor, solution, and postprocessor<sup>27</sup>. In this study, ABAQUS software is used to calculate the stress intensity factor of the edge crack in finite plate.

**Mesh Convergence Study:** A mesh convergence study was done to choose the optimum mesh number from the computational accuracy point of view. Meanwhile, SIF was computed for different types of meshing. In order to get better result in different analysis with ABAQUS software, mesh convergence study was done in the sample simulations.

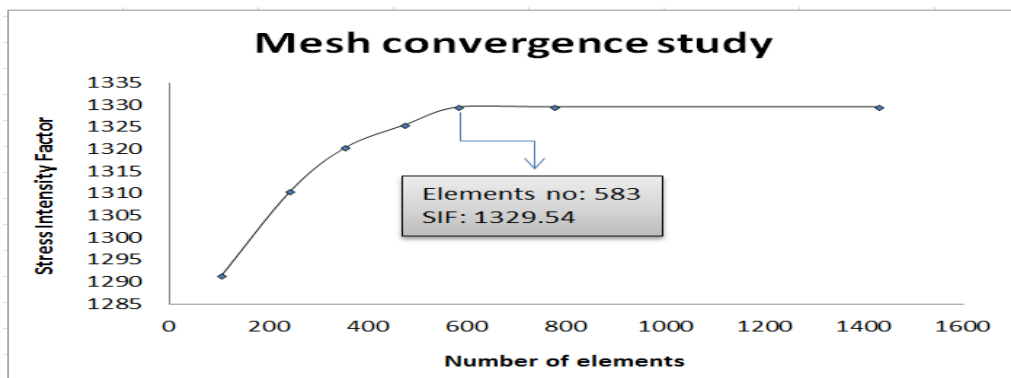

Figure-3

Trend line of mesh convergence study

As it is shown in figure-3, by increasing the number of elements, SIF goes up sharply and then approximately remains steady. The mesh convergence study was started with 104 elements that increase until 1430 elements. In the first test, SIF is 1291.4, which goes up until 1329.58 in the last test at 1430 elements. As it is shown, with 583 elements, SIF stops its sharp increase at 1329.54 and keeps its very slight rise until the last point. As it is shown in the figure 3, the point with 583 elements is a proper point to be utilized in all simulations. Figure-4, demonstrates a meshed blade with 583 elements.

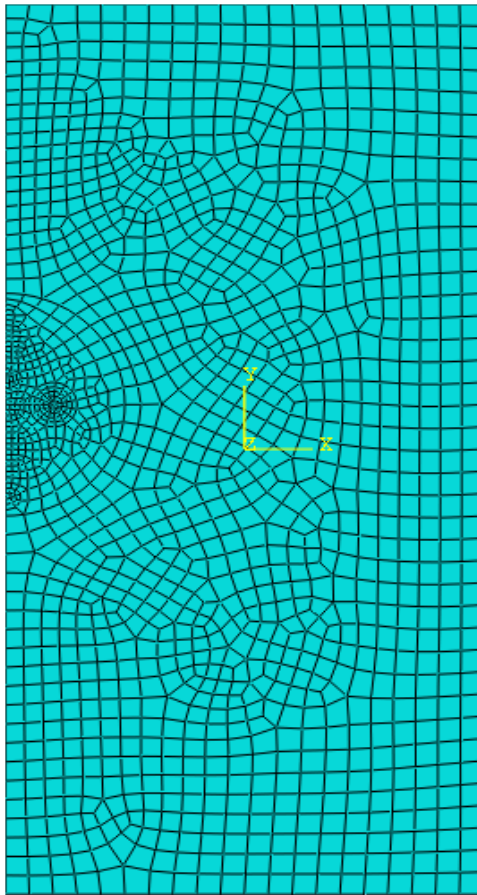

Figure-4  
Meshed plate with 583 elements,  $h=10$

**Validation of Software's Result with the Formula:** By comparing the two amounts of  $K_I$  which are calculated from software and formula, the method of using ABAQUS software will be validated.

In the case of  $h=0$ , the edge crack is in the middle of the length,  $K_I$  which is calculated by software is 1333.22, and according to the formula (3),  $K_I$  is 1326.9 which has just 0.4% error that is negligible.

According to this validation, method of calculating  $K_I$  in ABAQUS can be used in calculation of  $K_I$  in various  $h$ .

**Neural Network Method:** Neural network algorithm functions on the base of real biological neuron. The modern application of this algorithm which is referred to ANN (Artificial Neuron Network) is used to model complex nonlinear systems that are not easily modeled with the closed-form equations<sup>28</sup>. MATLAB software has the ability to use this algorithm to find the most appropriate solution that fits data as well<sup>29</sup>.

This study uses neural FF network and Back Propagation Training Algorithm to predict the trend of changing SIF in various positions along Y axis. In addition, two-layer function, Logsig and Purel in transfer functions, and adaptive training are used to solve this problem in MATLAB.

### Results and Discussion

In this section, stress intensity factor in the first mode,  $K_I$ , is calculated in various edge crack position along Y axis. Figure 5 illustrates the deformed plate under 200 kPa uniaxial stress. In this sample simulation,  $K_I$  is 1333.37.

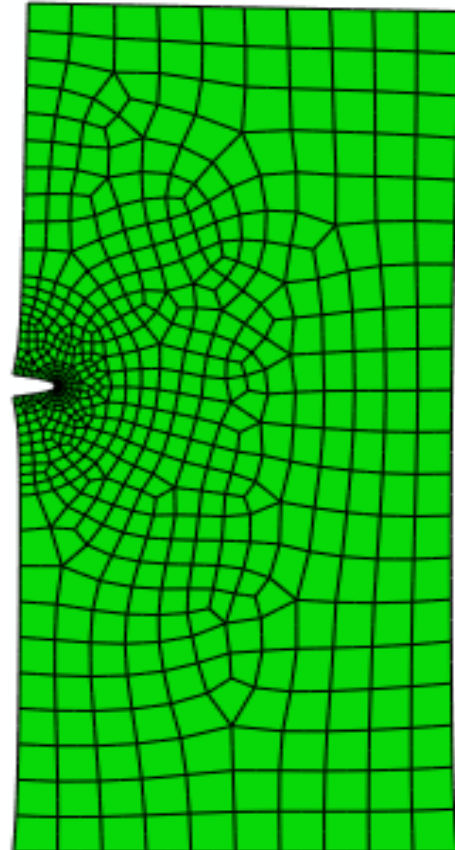

Figure-5  
Deformed finite plate under 200 kPa stress loading. Plate thickness is 1mm, and  $h$  is 10mm

Figure-6 shows the deformed plate under 200 kPa uniaxial stress. In this simulation  $h=80$ mm. The stress intensity factor is 1629.48.

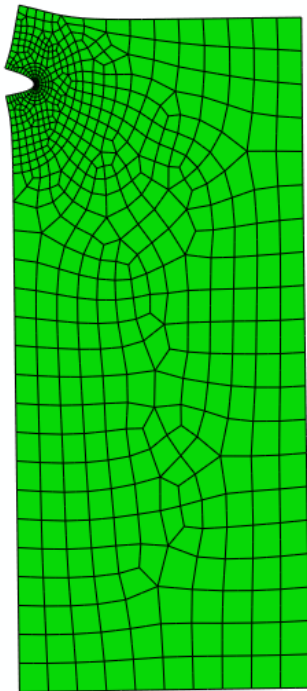

Figure-6

Deformed finite plate under 200 kPa stress loading. Plate thickness is 1mm, and h is 80mm

SIF is calculated in various h, -90 to +90. Figure-7 illustrated the trend of changing SIS in various positions along Y axis.

As it is shown above, by changing the h from -90 to +90, SIF increases. As the plate and loading is symmetric, SIF is the same for +h and -h in all position.

The graph increases slightly from h=0 to h=70, after that, the graph rises sharply to the maximum amounts.

In the middle of the plate, h=0, SIF is 1333.22. Furthermore, the maximum of SIF is 2269.17 at h=±90.

### Conclusion

The objective of this paper was finding the correlation of the stress intensity factor and position of edge crack along Y axis in finite plate. The plate size was 100mm \* 200mm (rectangular), and it was made from steel with the Poisson ratio of 0.3 and elasticity modulus of 300Gpa. The edge crack length was 10 mm.

It examined the mentioned variables by the use of finite element method and predicted the stress intensity factor trend in various position along the length of the plate by the use of Neural Network method.

In order to complete this study, the basic concepts related to the fracture mechanics were elaborated. Furthermore, an investigation of the previous study was done. Then, ABAQUS software was adopted to utilize finite element method to calculate the stress intensity factor in the finite plate with an edge crack under uniaxial stress loading. Different edge crack positions were analyzed. In order to predict the stress intensity factor trend in all the positions of edge crack, Neural Network method was utilized.

The results showed that stress intensity factor for the cracks, which are near the middle of the plate, is higher than the cracks that are near to the top and bottom of the plate.

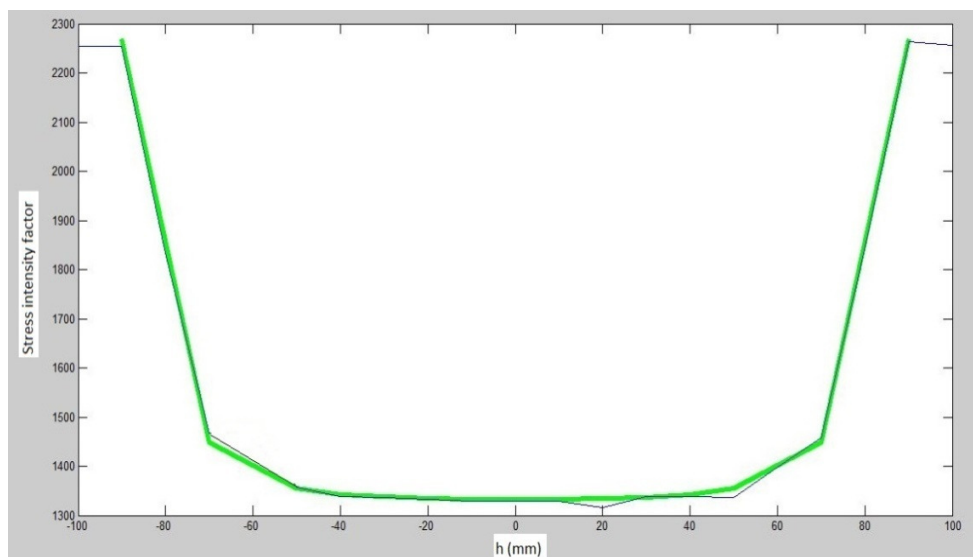

Figure-7

Stress intensity factor vs. edge crack position along Y axis, h

## References

1. Tada H., Paris P.C., Irwin G.R. and Tada H., The Stress Analysis of Cracks Handbook, (130), (2000)
2. Irwin G., Crack-Extension Force for a Part-through Crack in a Plate, (1997)
3. Irwin G.R., Analysis of Stresses and Strains near the End of a Crack Traversing a Plate, *J. Appl. Mech.*, (1957)
4. Rooke D.P. and Cartwright D.J., Compendium of Stress Intensity Factors, *Procurement Executive, Ministry of Defence. H. M. S. O. 1976, 330 p(Book)* (1976)
5. Ayhan A.O., Mixed Mode Stress Intensity Factors for Deflected and Inclined Surface Cracks in Finite-Thickness Plates, *Engineering fracture mechanics*, **71(7)**, 1059-79 (2004)
6. Limtrakarn W. and Dechaumphai P., Adaptive Finite Element Method to Determine  $K_I$  and  $K_{II}$  of Crack Plate with Different Inclusion/Eplate Ratio, *Transactions of the Canadian Society for Mechanical Engineering*, **35(3)**, 355 (2011)
7. Hertzberg R.W. Vinci R.P. and Hertzberg J.L., Deformation and Fracture Mechanics of Engineering Materials, (89), (1996)
8. Kitey R., Phan A.V., Tippur H. and Kaplan T., Modeling of Crack Growth through Particulate Clusters in Brittle Matrix by Symmetric-Galerkin Boundary Element Method, *International journal of fracture*, **141(1-2)**, 11-25 (2006)
9. Xu K., Lie S. and Cen Z., Crack Propagation Analysis with Galerkin Boundary Element Method, *International journal for numerical and analytical methods in geomechanics*, **28(5)**, 421-35 (2004)
10. Luliang L. and Pan Z., Meshless Method for 2d Mixed-Mode Crack Propagation Based on Voronoi Cell, *ACTA Mechanica Solida Sinica-English Edition-*, **16(3)**, 231-39 (2003)
11. Rao B. and Rahman S., An Efficient Meshless Method for Fracture Analysis of Cracks, *Computational mechanics*, **26(4)**, 398-408 (2000)
12. Atluri S. and Nishioka T., Computational Methods for Three-Dimensional Problems of Fracture, (1986)
13. Kim J.H. and Paulino G.H., Simulation of Crack Propagation in Functionally Graded Materials under Mixed-Mode and Non-Proportional Loading, *Mechanics and Materials in Design*, **1(1)**, 63-94 (2004)
14. Barsoum R.S., On the Use of Isoparametric Finite Elements in Linear Fracture Mechanics, *International Journal for Numerical Methods in Engineering*, **10(1)**, 25-37 (1976)
15. Alshoaibi A.M., Hadi M. and Ariffin A., An Adaptive Finite Element Procedure for Crack Propagation Analysis, *Journal of Zhejiang University Science A*, **8(2)**, 228-36 (2007)
16. Tracey D., Finite Elements for Three-Dimensional Elastic Crack Analysis, *Nuclear Engineering and Design*, **26(2)**, 282-90 (1974)
17. Raju I., and Newman J., Stress-Intensity Factors for a Wide Range of Semi-Elliptical Surface Cracks in Finite-Thickness Plates, *Engineering Fracture Mechanics*, **11(4)**, 817-29 (1979)
18. Kim J.H. and Paulino G.H., Finite Element Evaluation of Mixed Mode Stress Intensity Factors in Functionally Graded Materials, *International Journal for Numerical Methods in Engineering*, **53(8)**, 1903-35 (2002)
19. Phongthanapanich S., and Dechaumphai P., Adaptive Delaunay Triangulation with Object-Oriented Programming for Crack Propagation Analysis, *Finite Elements in Analysis and Design*, **40(13)**, 1753-71 (2004)
20. Newman Jr J., and Raju I., Stress-Intensity Factor Equations for Cracks in Three-Dimensional Finite Bodies Subjected to Tension and Bending Loads, *Computational methods in the mechanics of fracture*, **2(S N)**, 312-34 (1986)
21. DeLorenzi H. G., Energy Release Rate Calculations by the Finite Element Method, *Engineering Fracture Mechanics*, **21(1)**, 129-43 (1985)
22. Blackburn W., and Hellen T., Calculation of Stress Intensity Factors in Three Dimensions by Finite Element Methods, *International Journal for Numerical Methods in Engineering*, **11(2)**, 211-29 (1977)
23. Sanjay P.T., and Sunil P., Aspect of Finite Element Analysis Methods for Prediction of Fatigue Crack Growth Rate, *Research Journal of Recent Sciences*, **1(2)**, 85-91 (2012)
24. Foroni F., Moreira Filho L., and Menezes M., Blade Design and Forming for Fans Using Finite Elements, *Innovative Algorithms and Techniques in Automation, Industrial Electronics and Telecommunications*, 135-40, (2007)
25. Zare A., Munisamy K. M., Najafzadeh A., Shahizare B., Ahmadi A., and Jaafari A. A., Finite Element Analysis of Axial Fan Blade with Different Chord Lengths, *Indian Journal of Science and Technology*, **6(5)**, 4403-09 (2013)
26. Zienkiewicz O. C., Taylor R. L., and Zhu J. Z., The Finite Element Method: Its Basis and Fundamentals: Its Basis and Fundamentals, (2005)
27. Krishan K., and Aggarwal M., A Finite Element Approach for Analysis of a Multi Leaf Spring Using Cae Tools, *Research Journal of Recent Sciences* (2012)
28. Hagan M. T., Demuth H. B., and Beale M. H., Neural Network Design, (1996)
29. Demuth H., Beale M., and Works M., Matlab: Neural Network Toolbox: User's Guide, (1992)